

# SMART TWEEZERS

## R-C-L METER



MODEL ST5 - S  
User's Manual

---

# TABLE OF CONTENTS

<b>Notice</b>	1
<b>Warranty</b>	1
<b>Safety Precautions</b>	2
<b>Getting Started</b>	3
Overview	3
Controls	6
Power On	7
Menu Structures And Functions	9
<b>Measurement Features</b>	20
Measuring Resistance	20
Measuring Capacitance	20
Measuring Inductance	21
<b>Maintenance</b>	22
<b>Labelling &amp; Verification Requirements</b>	23
<b>Appendix A. Specifications</b>	24
<b>Appendix B. Default Settings</b>	25
<b>Appendix C. Accuracy Specification</b>	26

---

**NOTICE:** TO THE BEST OF OUR KNOWLEDGE THIS DOCUMENT IS BELIEVED TO BE ACCURATE. THE MANUFACTURER RESERVES THE RIGHT TO CHANGE THE INFORMATION AND DOES NOT ASSUME ANY RESPONSIBILITY FOR OMISSIONS AND/OR ERRORS FOUND IN THIS DOCUMENT.

**WARRANTY:** MANUFACTURER WARRANTS THIS PRODUCT TO BE FREE FROM DEFECTS IN MATERIALS AND WORKMANSHIP FOR A PERIOD OF ONE (1) YEAR FROM THE SHIPMENT DATE. MANUFACTURER WARRANTS THE FOLLOWING ITEMS FOR NINETY (90) DAYS FROM THE DATE OF SHIPMENT: RECHARGEABLE BATTERIES, DISKS AND DOCUMENTATION. DURING THE WARRANTY PERIOD, THE MANUFACTURER WILL, AT ITS DISCRETION, EITHER REPAIR OR REPLACE ANY PRODUCT THAT PROVES TO BE DEFECTIVE. TO EXERCISE THIS WARRANTY, WRITE OR CALL YOUR LOCAL DISTRIBUTOR. YOU WILL BE GIVEN PROMPT ASSISTANCE AND RETURN INSTRUCTIONS. PLEASE SEND THE PRODUCT WITH SHIPPING PREPAID TO THE INDICATED SERVICE FACILITY. REPAIRS WILL BE MADE AND THE PRODUCT WILL BE RETURNED TO YOU. REPAIRED OR REPLACED PRODUCTS ARE WARRANTED FOR THE BALANCE OF THE ORIGINAL WARRANTY PERIOD, OR NINETY (90) DAYS FROM THE DATE OF THE REPAIR.

THIS WARRANTY DOES NOT COVER THE REPAIR OF ANY PRODUCT WHOSE SERIAL NUMBER HAS BEEN ALTERED, DEFACED OR REMOVED. THIS WARRANTY DOES NOT COVER FINISHES (SCRATCHES ON SURFACE OR SCREEN), NORMAL WEAR AND TEAR, NOR DOES IT COVER DAMAGE RESULTING FROM MISUSE, DIRT, LIQUIDS, PROXIMITY OR EXPOSURE OF HEAT, ACCIDENT, ABUSE, NEGLIGENCE, MISAPPLICATION, OPERATION OUTSIDE OF THE ENVIRONMENTAL SPECIFICATIONS, TAMPERING, UNREASONABLE USE, SERVICE PERFORMED OR ATTEMPTED BY UNAUTHORIZED SERVICE CENTERS, FAILURE TO PROVIDE REASONABLE AND NECESSARY MAINTENANCE.

THIS WARRANTY DOES NOT APPLY TO DEFECTS RESULTING FROM PRODUCT MODIFICATION WITHOUT MANUFACTURER'S EXPRESS WRITTEN CONSENT, OR MISUSE OF ANY PRODUCT OR PART. THIS WARRANTY ALSO DOES NOT APPLY TO SOFTWARE, NON-RECHARGEABLE BATTERIES, DAMAGE FROM BATTERY LEAKAGE, AND IMPROPER POLARITY OF THE BATTERIES OR PROBLEMS ARISING FROM NORMAL WEAR OR FAILURE TO FOLLOW INSTRUCTIONS. THIS WARRANTY DOES NOT COVER LCD DAMAGE, PHYSICAL DAMAGE TO THE JOG DIAL BUTTON, SLIDE SWITCH AND RESET SWITCH; ELECTRICAL DAMAGE OF THE PRODUCT DUE TO HIGH VOLTAGE OR IMPROPER BATTERY TYPE.

THE DESIGN AND IMPLEMENTATION OF ANY CIRCUIT BASED ON THIS PRODUCT IS THE SOLE RESPONSIBILITY OF THE CUSTOMER. MANUFACTURER DOES NOT WARRANT ANY DAMAGE THAT OCCURS AS A RESULT OF THE USER'S CIRCUIT OR ANY DEFECTS THAT RESULT FROM USER-SUPPLIED PRODUCTS. THIS WARRANTY DOES NOT APPLY TO REPAIRS OR REPLACEMENTS NECESSITATED BY ANY CAUSE BEYOND THE CONTROL OF FACTORY INCLUDING, BUT NOT LIMITED TO, OPERATION CONTRARY TO FURNISHED INSTRUCTIONS, SHIPPING ACCIDENTS, MODIFICATION OR REPAIR BY THE USER, NEGLIGENCE, ACCIDENTS OR OTHER ACTS OF GOD.

THE FOREGOING IS IN LIEU OF ALL OTHER EXPRESSED WARRANTIES AND THE MANUFACTURER DOES NOT ASSUME OR AUTHORIZE ANY PARTY TO ASSUME FOR IT ANY OBLIGATION OR LIABILITY. THE DURATION OF ANY WARRANTIES THAT MAY BE IMPLIED BY LAW (INCLUDING THE WARRANTIES OF MERCHANTABILITY AND FITNESS) IS LIMITED TO THE TERM OF THIS WARRANTY. IN NO EVENT SHALL THE MANUFACTURER BE LIABLE FOR SPECIAL, INCIDENTAL OR CONSEQUENTIAL DAMAGES ARISING FROM OWNERSHIP OR USE OF THIS PRODUCT, OR FOR ANY DELAY IN THE PERFORMANCE OF ITS OBLIGATIONS UNDER THIS WARRANTY DUE TO CAUSES BEYOND ITS CONTROL. THIS WARRANTY IS LIMITED IN DURATION TO ONE (1) YEAR FROM THE DATE OF ORIGINAL PURCHASE.

THIS WARRANTY IS IN LIEU OF ALL OTHER WARRANTIES, EXPRESSED OR IMPLIED, INCLUDING ANY IMPLIED WARRANTY OF MERCHANTABILITY OR FITNESS FOR A PARTICULAR USE. THE REMEDIES PROVIDED HEREIN ARE BUYER'S SOLE AND EXCLUSIVE REMEDIES. NEITHER MANUFACTURER, NOR ANY OF ITS EMPLOYEES SHALL BE LIABLE FOR ANY DIRECT, INDIRECT, SPECIAL, INCIDENTAL OR CONSEQUENTIAL DAMAGES ARISING OUT OF THE USE OF ITS DEVICES AND SOFTWARE EVEN IF MANUFACTURER HAS BEEN ADVISED IN ADVANCE OF THE POSSIBILITY OF SUCH DAMAGES. SUCH EXCLUDED DAMAGES SHALL INCLUDE, BUT ARE NOT LIMITED TO: COSTS OF REMOVAL AND INSTALLATION, LOSSES SUSTAINED AS THE RESULT OF INJURY TO ANY PERSON, OR DAMAGE TO PROPERTY.

## SAFETY PRECAUTIONS

The following safety precautions should be observed prior to using this product and any associated accessories. Although devices and accessories would normally be used with non-hazardous voltages, there are situations where hazardous conditions may be present.

This product is intended for use by qualified personnel who recognize shock hazards and are familiar with the safety precautions required to avoid possible injury. Read and follow all installation, operation, and maintenance instructions carefully before using the product. Refer to the manual for complete product specifications.

If the product is used in a manner not specified, the protection provided by the product may be impaired.

Inspect the Smart Tweezers case before using.  
Do not use the device if it appears to be damaged.

- Do not use the device if it operates abnormally.
- Do not attempt to measure any components in-circuit when your circuit is alive or active.

### **To avoid possible damage to Smart Tweezers or to the equipment under test, follow these guidelines:**

- Disconnect circuit power supply and discharge all high-voltage capacitors before testing resistance, inductance, or capacitance.
- Do not apply external voltages of more than 1.6 V.
- Use proper terminals and functions for your measurements.
- Only supplied charger (DC 5V) should be used to charge the battery.

### **SAFETY SYMBOLS AND TERMS**

The WARNING heading in this manual indicates dangers that might result in personal injury or death. Always read the associated information very carefully before performing the indicated procedure.

The CAUTION heading in the manual indicates hazards that could damage the device. Such damage may invalidate the warranty.

## GETTING STARTED

This section summarizes basic operation of Smart Tweezers. In the section:

**OVERVIEW:** Overview of the device controls.

**POWER-ON:** Describes the power-on and power-off sequence, the warm-up time, and default conditions.

**DISPLAY:** Discusses the display format and messages that may appear while using the device.

**MENU STRUCTURE:** Covers menu structure, system settings and features.

## OVERVIEW

Smart Tweezers (ST) is a portable impedance measuring device. ST is capable of measuring resistance, capacitance or inductance over a range of more than 8 orders of magnitude. The device has a basic accuracy better than 0.2% (resistance) and operates at four test frequencies.

Smart Tweezers is controlled by a microcontroller that sets measurement conditions, processes data and operates the display and user interface. The device has a unique mechanical design that allows manipulation SMT components with size down to 0201.

In actual use Smart Tweezers provides more accurate results than most of the benchtop LCR meters due to small and very predictable parasitics of its probes. Probability of measurement errors associated with setup (wires, tips, probes and etc.) is minimal.

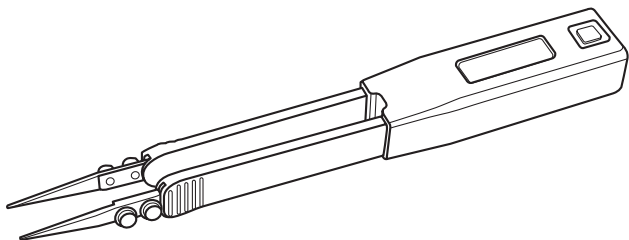

## HOW IT WORKS

ST evaluates impedance of a component by measuring the voltage across the component and current through it. The complex ratio of voltage to current is equal to the complex impedance. The unit's processor calculates various parameters that are displayed i.e. R, C or L.

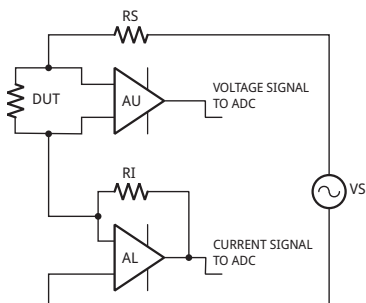

Voltage across the component is generated by the test signal source  $V_s$ . Both the amplitude and frequency of  $V_s$  can be set. The voltage is applied to the device under test (DUT) through the source resistance  $R_s$ . Current flows to the virtual ground of the current amplifier AI, and through the current conversion resistor  $R_i$ . The output of AI provides a signal proportional to the current,  $I \cdot R_i$ .

Voltage across the DUT is measured by a separate signal path (amplifier AU), thus providing a pseudo 4-wire Kelvin connection.

Voltage and current signals are processed by the A/D converter. Obtained values are then corrected using calibration factors, converted to impedance and sent to the display.

There are four selectable frequencies: 100Hz, 120Hz, 1.0kHz and 10kHz. The output frequency is accurate to 50 ppm (0.005%). Frequencies are set in the menu or by moving the Navigation Control UP.

There are three output voltage levels that can be selected: 0.5  $V_{rms}$  and 1.0  $V_{rms}$ . The accuracy of the output voltage levels is 2 %.

The output voltage is applied to the device under test through the source impedance. The voltage across the device is always less than or equal to the output voltage. The source impedance value is 100 $\Omega$ .

Certain devices require a specific test voltage, such as Z5U ceramic capacitors (test voltage = 0.5 Vrms for 25V parts and 1.0V for < 16V parts).

Note: Use the largest voltage possible for the best SNR and accuracy.

## CONTROLS

### The Navigation Control

The navigation switch is used to select a function or to change a setting of Smart Tweezers. The navigation switch can be moved (rocked) in 4 directions (UP, DOWN, LEFT, RIGHT). Selection is performed by pressing along the vertical axis (PRESS).

### Quick Controls

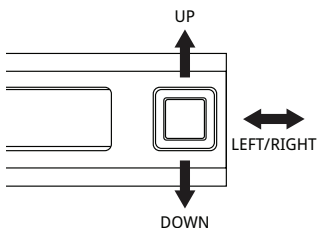

The Quick Controls allow changing test parameters or modes without entering the general menu by moving the Navigation Control UP, DOWN, LEFT and RIGHT as shown below.

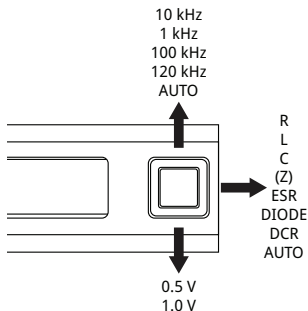

**Note:** To avoid errors do not use the Quick Controls during component measurement.

**UP** – change test ranges

**DOWN** – change test signal levels

**LEFT/RIGHT** – change measurement modes

## POWER ON

**POWER-ON** - To turn the Smart Tweezers ON, press the navigation switch twice.

**Note:** Once powered on, the unit will perform the last selected function.

**POWER-OFF** - ST6 powers off automatically if neither a measurement is performed nor the navigation control is operated for approximately 30 seconds (default value).

The power off timeout value can be set by changing the TIMEOUT setting in the SYSTEM menu.

The default power-off timeout is 30 seconds in a measurement mode and 30 seconds in the MENU mode.

**Note:** Automatic power-off does not occur if test frequency is manually set to 10kHz.

## DISPLAY

The screen is divided in four areas:

- Primary Display
- Secondary Display
- Test Parameters
- Device Status with Test Mode Indicator

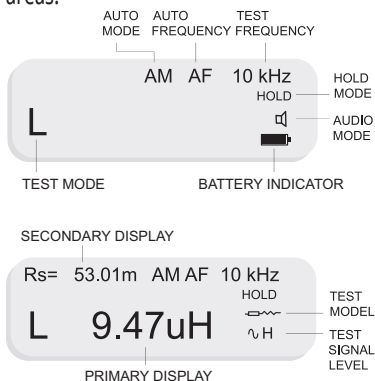



**PRIMARY DISPLAY:** The Primary Display is located in the middle of the screen and uses the largest font. It shows the dominant impedance parameter reading typically with 5 digits displayed.

**SECONDARY DISPLAY:** The Secondary Display is located just above the Primary Display. It shows the minor impedance parameter reading.

**TEST PARAMETERS:** The Test Parameters area is at the top of the screen and provides information about current test conditions such as Test Frequency, Range, Test Signal level, Test Model.

**DEVICE STATUS:** The Device Status area is at the bottom of the screen and provides information about the current Test Mode and settings of the device: Hold, Audio and Battery Status.

**TEST MODE INDICATOR:** The Test Mode Indicator sign is located immediately to the left of the Primary Display.

Symbols A, R, L, C, |Z|, ESR and Diode indicate Auto, Resistance, Inductance, Capacitance, Impedance and ESR measurement and Diode Test mode respectively.

## DISPLAYED PARAMETERS

The measurement mode setting (R, L+R, C+R, C+D, L+Q, |Z|, ESR and AUTO) determines the measurement type and the displayed parameters

**R MODE:** Resistance is shown on the Primary The resistance displayed is either the equivalent series or parallel resistance of the DUT. Resistance units are m $\Omega$ ,  $\Omega$ , k $\Omega$ , or M $\Omega$ .

**L+R MODE:** Inductance is shown on the Primary Display and the series resistance on the Secondary Display. The units of inductance are  $\mu$ H, mH or H. Resistance is the real part of the impedance. Resistance units are m $\Omega$  or  $\Omega$ . Serial equivalent circuit is used in this mode.

**L+Q MODE:** Inductance is shown on the Primary Display and the quality factor Q on the Secondary Display. Inductance units are  $\mu$ H, mH or H. Q is the ratio of the imaginary part of the impedance to the real part of the impedance. Q is dimensionless and the same for both series and parallel representations. A good inductance has a large L and a small R and thus a high Q..

**C+R MODE:** Capacitance is shown on the Primary Display and the parallel resistance R, is shown on the Secondary Display. The units of capacitance are pF, nF, or  $\mu$ F. Resistance units are  $\Omega$  or k $\Omega$ . Parallel ( $C < 500$  pF) or serial ( $C > 500$  pF) equivalent circuit diagram is used.

**C+D MODE:** Capacitance is shown on the Primary Display and dissipation factor D on the Secondary Display. The capacitance is either the equivalent series or parallel capacitance of the DUT. The units of capacitance are pF, nF,  $\mu$ F or mF. D is the ratio of the real part of the impedance to the imaginary part of the impedance, or  $1/Q$ . D is dimensionless and the same for series and parallel representations. A good capacitor has a large C (imaginary) and a small R (real) and thus a low D.

**|Z| MODE:** The Impedance of the component is shown on Primary Display. Units are m $\Omega$ ,  $\Omega$ , k $\Omega$ , or M $\Omega$ .

**ESR MODE:** The equivalent series resistance of the capacitor is shown on the Primary Display. ESR units are m $\Omega$ ,  $\Omega$ , k $\Omega$ , or M $\Omega$ .

**AUTO MODE:** ST determines which component model is the most accurate representation of the DUT and automatically selects the appropriate parameter set. The determination is made as follows:

- For  $|Q| < 0.15$  the R mode is selected.
- For  $Q > +0.15$  the L+R or L+Q mode is selected (depends on user settings).
- For  $Q < -0.15$  the C+R or C+D mode is selected.
- For  $C < 500$  pF Parallel circuit diagram (Rp) is used.
- For  $C \geq 500$  pF Serial circuit diagram (Rs) is used.

## MENU STRUCTURES AND FUNCTIONS

This section describes menu structure and device parameters setting. Smart Tweezers menu system contains

- Main menu — main menu items
- System menu — system menu items
- Sound menu – sound settings
- Display menu — display settings

- Service menu — service functions
- Measurement menu – measurement functions and settings
- Mode menu – measurement modes
- Setting menu – measurement parameters settings

## NAVIGATING MENUS

Move the Navigation Control UP or DOWN to move cursor to the desired menu item and PRESS it to select the item. The Current Setting cursor indicates the current setting.

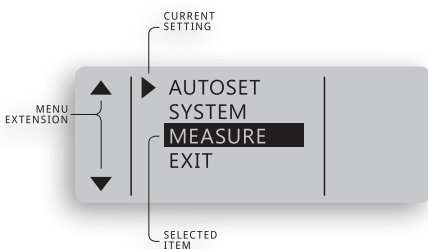

## MAIN MENU

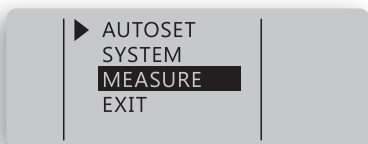

Main menu is used to access System menu, Measurement menu or to restore measurement parameters to the default state using Autoset.

- Select AUTOSET to reset parameters to the default settings.
- Select SYSTEM to change user interface and operation parameters.
- Select MEASURE to specify measurement settings.

## SYSTEM MENU

System menu is used to access system settings and functions.

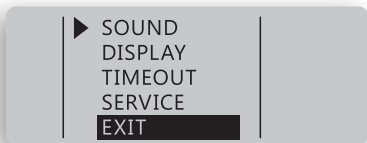

## SOUND MENU

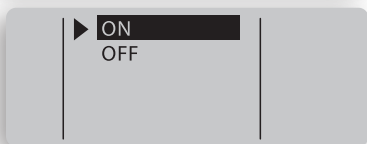

Sound menu is used to change the sound setting for measurement confirmation.

Select ON  to enable the measurement confirmation sound.

Select OFF  to disable sound for all functions except for the Navigation Control operation.

Select R-TONE to enable a special mode when beep frequency varies depending on the measured resistance value in the Resistance Mode (see the Measurement Menu section). Resistance thresholds for the R-TONE variations are preset to

- Higher than 20 Ohm
- 10 Ohm
- 5 Ohm
- Ohm
- 0.5 Ohm and lower.

The mode could be used for locating shorted part of a circuit e.g. on a PCB.

## DISPLAY MENU



Display menu is used to change display's settings

- Select RIGHT to set the "Right Handed" display mode
- Select LEFT to set the "Left Handed" display mode

## CONTRAST

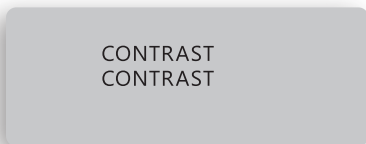

Select CONTR to adjust display contrast. Move Navigation Control UP or DOWN to change contrast. PRESS to exit menu at the adjusted contrast level.

## TIME OUT

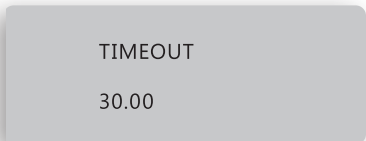

Select TIMEOUT to adjust the timeout before the unit goes to sleep mode. Move Navigation Control UP or DOWN to change the timeout value (10sec - 200sec) PRESS to exit the menu..

## SERVICE MENU

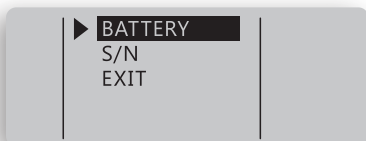

## BATTERY

4.18 V

Select BATTERY to measure the actual battery voltage. PRESS to exit

## SERIAL NUMBER

Select S/N to display the device Serial Number and the firmware version.

# MEASUREMENT MENU

Measurement modes and settings

## MODE MENU

The Mode menu is used to set the measurement mode. Select RES, IND, CAP, IMP or ESR menu items to measure desirable component or



▶ MODE  
SETTING  
HOLD  
PERIOD  
EXIT

parameter as Resistance, Inductance, Capacitance, Impedance and ESR accordingly. For automatic measurement select AUTO (default).

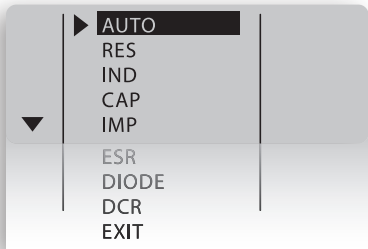

▶ AUTO  
RES  
IND  
CAP  
IMP  
▼ ESR  
DIODE  
DCR  
EXIT

**AUTO MODE:** Select AUTO mode (AM sign appears at the left bottom corner of display) for automatic measurement of inductance, capacitance or resistance.

**Note:** In the AUTO mode ST uses 1kHz test frequency by default and has a limited sensitivity. Automatic detection may not work for small value capacitors and inductors. In this case 10kHz test frequency must be used..

**RESISTANCE MODE:** Enables Resistance measurement mode. See section MEASUREMENT FEATURES for more information.

**INDUCTANCE MODE:** Enables Capacitance measurement mode. See section MEASUREMENT FEATURES for more information.

**CAPACITANCE MODE:** Enables Capacitance measurement mode. See section MEASUREMENT FEATURES for more information.

**IMPEDANCE MODE:** Enables the Impedance measurement mode.

**Note:** See section MEASUREMENT FEATURES for more information.

**ESR MODE:** Enables the ESR measurement mode. See section MEASUREMENT FEATURES for more information.

**DIODE TEST MODE:** Enables diode test mode showing diode polarity or SHORT indicating a faulty diode



**DCR MODE:** Enables DCR resistance measurement mode. The DCR measurement measures the resistance of an unknown component by applying DC voltage.

# SETTING MENU

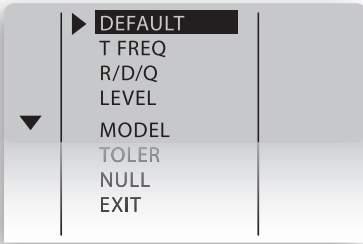

Use this menu to set specific measurement parameter.

## TEST FREQUENCY MENU

Use this menu to set desired test frequency.

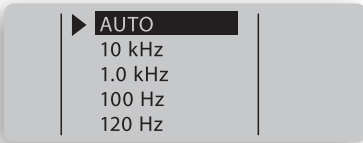

## RDQ MENU

Use this menu to set secondary display parameter.

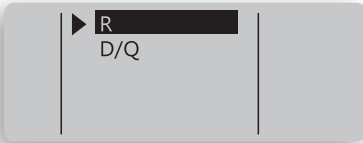

The following combinations are allowed:

- C+R capacitance + resistance
- C+D capacitance + dissipation factor
- L+R inductance + resistances
- L+Q inductance + quality factor



## LEVEL MENU

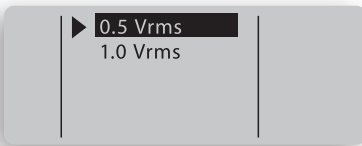

Use this menu to set desirable test signal level.  
Default value is 1.0 Vrms.

**Note:** 1.0 Vrms is equal to 2.8 Vp-p

## MODEL MENU

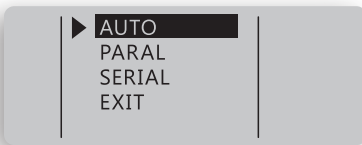

Any non-ideal component can be represented as a resistive component in series or in parallel with a reactive component. Depending upon the characteristics of the component the series or parallel model will be more accurate. In most cases, parts are best approximated by the series model. Manufacturers often specify which representation should be used when testing their devices.

The LCR meter can display Automatic (A) Parallel ( S ) or Series ( P ) model data. Use this menu to choose the parallel and series model.

Series model is set as the default setting

## TOLERANCE MENU

This function is designed for component sorting. It checks whether the measured component is within preset tolerance from the reference component. The tolerance ranges available are 1%, 5%, 10%, and 20%.

To preset a tolerance range:

- Select manual L, C or R measurement mode (see MODE menu)
- Enable the HOLD mode (see HOLD menu)
- Connect to an appropriate component selected as a reference value
- Enter the TOLERance menu and select desired tolerance range

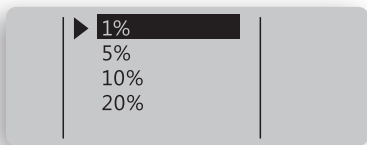

Smart Tweezers will display difference in percent from the reference value and the beeper will beep

- 1 time when the component is within the setting tolerance.
- 3 times whenever the component under test exceeds the setting tolerance.

To reset the tolerance mode select AUTOSSET from the main menu or DEFAULT from the settings menu.

## **NULL MENU**

Allows storing of measurement offsets to perform relative measurements (NULL).

When relative measurements are performed, also called null, each reading is the difference between a stored (measured) relative value or offset and the input signal.

One common application is to increase the accuracy of a small resistance measurement by storing (nulling) the test lead resistance (test leads shorted).

Obtaining the leads offset (nulling) is also particularly important prior to making small capacitance measurements (test leads open).

Smart Tweezers allows to store measurement offset for L, C, R component separately.

To store an offset

- Select manual L, C or R measurement mode (see MODE menu)
- Enable the HOLD mode (see HOLD menu)
- Obtain offset value by measuring a component or by nulling test leads (see examples below)
- Enter the NULL menu and select SET

**Example 1:** Nulling test leads for small resistance measurement

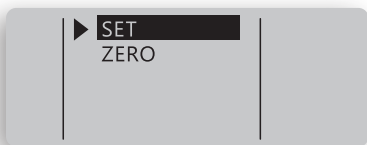

- Select manual R measurement mode (see MODE menu)
- Enable the HOLD mode (see HOLD menu)
- Short tweezers leads to obtain offset value
- Enter the NULL menu and select SET

**Example 2:** Nulling test leads for small capacitance measurement

- Select manual C measurement mode (see MODE menu) and 10kHz test frequency (see SETTINGS menu)
- Enable the HOLD mode (see HOLD menu)
- Bring tweezers leads to the distance equal to the size of the component to measure (e.g. 0.5 mm) to obtain capacitance offset value
- Enter the NULL menu and select SET

During measurements an asterisk will appear beside the test mode indicator for which the offset has been stored indicating relative measurement.

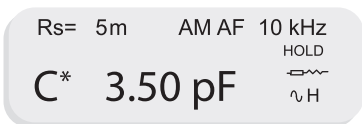

To reset (set to zero) the stored offset for a particular test mode

- Select manual L, C or R measurement mode (see MODE menu)
- Enable the HOLD mode (see HOLD menu)
- Enter the NULL menu and select ZERO

To reset the NULL mode completely select AUTOSSET from the main menu or DEFAULT from the SETTINGS menu.

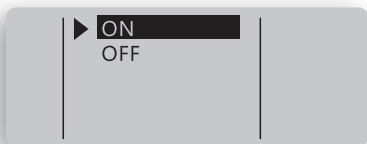

## HOLD MENU

Allows to hold last reading on display.

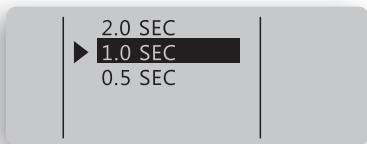

## PERIOD MENU

Period menu is used to set the time period between measurements. This setting does not affect measurement accuracy.

Default setting is 1sec.

**Note:** Short period may reduce the battery life.

## MEASUREMENT FEATURES

This section describes specific ST functions and settings.

Measuring resistance	Covers resistance measurements.
Measuring capacitance	Covers capacitance measurements.
Measuring inductance	Covers inductance measurements.
Testing diodes	Describes testing general-purpose diodes.

### MEASURING SMALL RESISTANCE

There is some small resistance offset due to the resistance of the tweezer tips, and resistance of the contacts between the tips and DUT. Typical offset value is less than 25 m $\Omega$  and may increase if the gold on the tweezer tips wears out. The offset value should be used in calculation of the actual resistance.

### MEASURING CAPACITANCE

Test frequency	0.1kHz/1 kHz/10kHz/120Hz
Test signal amplitude	0.5/1.0 Vrms Sine wave
Source impedance	100 $\Omega$
Test period	1 Sec (default)
Equivalent circuit diagram	Parallel (C < 500 pF), Serial (C > 500 pF)

In AUTO mode the Smart Tweezers first tries to perform measurement at 1kHz and then automatically selects the best test frequency. The device is capable of measuring capacitance from approximately 3 pF to 199  $\mu$ F in AUTO mode.

To measure capacitance lower than 4 pF select 10kHz test frequency manually. To measure capacitance higher than 200  $\mu$ F use 100Hz or 120Hz.

DUT	Optimal test frequency
<10000pF	10 kHz
10001pF- 10μF	1 kHz

There is some small capacitance offset due to capacitance of the tips. The offset depends on the distance between the tips (i.e. measured component size). The offset value should be used in calculation of the actual capacitance.

Table below shows typical offset values for different component sizes:

Component size	Offset, pF
1206	0.58
0805	0.6
0603	0.65
0402	0.7

## MEASURING INDUCTANCE

Test frequency	0.1kHz/1 kHz/10kHz/120Hz
Test signal amplitude	0.5/1.0 Vrms Sine wave
Source impedance	100 Ω
Test period	1 Sec (default)
Equivalent circuit diagram	Serial

In AUTO mode ST automatically selects the best test frequency and is capable of measuring inductance from 1 μH to 1kH. To measure inductance lower than 5μH or more than 500mH select test frequency manually:

DUT	Optimal test frequency
<1 mH	10 kHz
1 mH - 1000 mH	1 kHz
> 1000 mH	100 Hz

## ESR MEASUREMENTS

Use the ESR measurement to measure the equivalent series resistance of a capacitor independent of its capacitance.

Test frequency	0.1kHz/1 kHz/10kHz/120Hz
Test signal amplitude	0.5/1.0Vrms Sine wave
Source impedance	100 $\Omega$
Test period	1 Sec (default)
Equivalent circuit diagram	Serial

## MEASURING IMPEDANCE (|Z|)

All circuit components, resistors, capacitors, and inductors have parasitic components. Thus, simple components should be modeled as complex impedances.

Test frequency	0.1kHz/1 kHz/10kHz/120Hz
Test signal amplitude	0.5/1.0 Vrms Sine wave
Source impedance	100 $\Omega$
Test period	1 Sec (default)
Equivalent circuit diagram	Serial

## MAINTENANCE

**GENERAL MAINTENANCE:** Dirt or moisture on the tips may affect measurement accuracy. Clean the tips regularly. Do not use abrasives or solvents.

To clean the tips:

1. Shake off any dirt that may be on the tips.
2. Soak a swab in alcohol. Work the swab around each tip.

## LOW BATTERY INDICATION

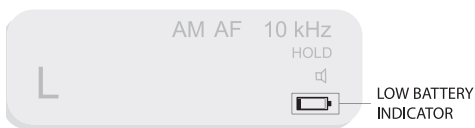

The empty battery icon on the display indicates that device's battery voltage is low and it should be recharged. The warning appears when the battery voltage drops below 3.55V, i.e. the batteries are about 90% depleted. The unit is still operational for a short time; however the batteries should be recharged as soon as possible

**Note:** To charge the battery use supplied USB (5V) charger or a computer USB port

## TROUBLESHOOTING

If there appears to be a malfunction during an operation of the device, the following steps could be performed in order to troubleshoot the problem:

1. Check battery voltage and recharge if necessary.
2. Review this manual for possible mistakes in the operating procedure.
3. Reset device by reconnecting battery (requires top lid and the circuit board removal).

**CAUTION:** Smart Tweezers repairs should only be performed by an Authorized Service Center or by qualified service personnel.

## LABELLING & VERIFICATION REQUIREMENTS

This device complies with Part 15 of the FCC Rules. Operation is subject to the following two conditions:

1. This device may not cause harmful interference; and,
2. This device must accept any interference received, including interference that may cause undesired operation.



# APPENDIX A. SPECIFICATIONS

## TECHNICAL SPECIFICATIONS

AC test mode Test frequency:	1 kHz, 10 kHz, 120Hz,100 Hz
Test frequency accuracy:	50 PPM (0.005%)
Test signal level:	0.5/1.0 +/- 5% Vrms Sine wave
Source impedance:	100Ω +/- 1%

## TYPICAL OFFSET:

Resistance	≤ 25 mΩ
Capacitance	0.65 pF
Inductance	100 uH

Offset value should be subtracted from measurement result for small value components ( $R < 10\Omega$ ,  $C < 100\text{ pF}$ ,  $L < 10\text{ }\mu\text{H}$ ).

## MEASUREMENT RANGES

Parameter	Measurement Range	Test frequency
Resistance	< 9.9 MΩ	1 kHz
Capacitance	< 9999 pF	10 kHz
	10000 pF to 10 μF	1 kHz
	> 10 uF	100 Hz
Inductance	0.5 μH to 1 mH	10 kHz
	1 mH to 1000 mH	1 kHz
	> 1000 mH	100 Hz

## MAXIMUM MEASUREMENT RANGES

Resistance R:	0.05 $\Omega$ to 9.9 M $\Omega$
Capacitance C:	0.5 pF to 999 $\mu$ F
Inductance L:	0.5 $\mu$ H to 999 mH
Quality factor Q:	0.001 to 1000 *
Dissipation factor D:	0.001 to 1000 *

## MAXIMUM RESOLUTION

Capacitance C:	0.1 pF
Inductance L:	0.1 $\mu$ H
Quality factor Q:	0.001
Dissipation factor D:	0.001
Phase angle F:	0.1 deg

\* indication of the parameter not implemented in some versions

<b>Auto mode Read-out:</b>	<b>Dominant parameter</b>
Equivalent circuit diagram	Serial/Parallel for C/R Serial for L/R
Manual Mode Read-out	Dominant or secondary parameter
Equivalent circuit diagram:	Parallel or serial
Measurement update rate:	Up to 4 measurements per second
Battery Type:	3.7V LiPO rechargeable 180mAH
Typical charge time:	2.5 hours, current <100mA
Calibration:	Recommended interval 1 year NIST traceable calibration

## APPENDIX B. DEFAULT SETTINGS

### Default settings after AUTOSET command

SOUND mode:	OFF
DISPAY mode:	No change
Contrast:	No change
Readings PERIOD:	1 sec
Measurement mode:	AUTO
Test frequency mode:	AUTO
Offset CALIBRATION:	No change

## APPENDIX C. ACCURACY SPECIFICATION

### RESISTANCE, IMPEDANCE.

Range	Resolution	100 Hz	1 kHz	10kHz
1 $\Omega$	0.001 $\Omega$	0.7% + 50	0.7% + 50	0.7% + 50
10 $\Omega$	0.01 $\Omega$	0.7% + 8	0.7% + 8	0.7% + 8
100 $\Omega$	0.01 $\Omega$	0.2% + 3	0.2% + 3	0.2% + 3
1000 $\Omega$	0.1 $\Omega$	0.2% + 3	0.2% + 3	0.2% + 3
10 k $\Omega$	0.001 k $\Omega$	0.2% + 3	0.2% + 3	0.2% + 3
100 k $\Omega$	0.01 k $\Omega$	0.5% + 5	0.5% + 5	0.5% + 5
1000 k $\Omega$	0.1 k $\Omega$	0.5% + 5	0.5% + 5	0.5% + 5
10 M $\Omega$	0.001 M $\Omega$	2.0% + 8	2.0% + 8	5.0% + 8

Accuracy for the ranges 1  $\Omega$  ~ 100  $\Omega$  is specified after subtract of the offset resistance.

## CAPACITANCE

Range	Resolution	100 Hz	120 Hz	1 kHz	10 kHz
1000 $\mu$ F	0.1 $\mu$ F	0.5% + 5	0.5% + 5	NA	NA
100 $\mu$ F	0.01 $\mu$ F	NA	0.3% + 3	0.5% + 5	NA
10 $\mu$ F	0.001 $\mu$ F	NA	0.2% + 3	0.2% + 3	NA
1 $\mu$ F	0.1 nF	NA	0.2% + 3	0.2% + 3	0.2% + 3
100 nF	0.01 nF	NA	0.2% + 3	0.2% + 3	0.5% + 3
10 nF	0.001 nF	NA	0.5% + 5	0.2% + 3	0.5% + 3
1000 pF	0.1 pF	NA	NA	0.5% + 5	0.5% + 3
100 pF	0.01 pF	NA	NA	0.5% + 10	0.8% + 20
10 pF	0.001 pF	NA	NA	NA	1.0% + 50

Accuracy for the ranges of 10 pF~1000 pF is specified after subtract of the stray capacitances for test leads.

## INDUCTANCE

Range	Resolution	100 Hz	1 kHz	10 kHz
10 $\mu$ H	0.001 $\mu$ H	NA	NA	1.0% + 5
100 $\mu$ H	0.01 $\mu$ H	NA	1.0% + 5	0.7% + 3
1 mH	0.1 $\mu$ H	0.7% + 10	0.5% + 3	0.5% + 3
10 mH	0.001 mH	0.5% + 3	0.2% + 3	0.5% + 3
100 mH	0.01 mH	0.5% + 3	0.2% + 3	NA
1 H	0.1 mH	0.2% + 3	NA	NA

\* at optimum test frequency, ranges, without calibration offset

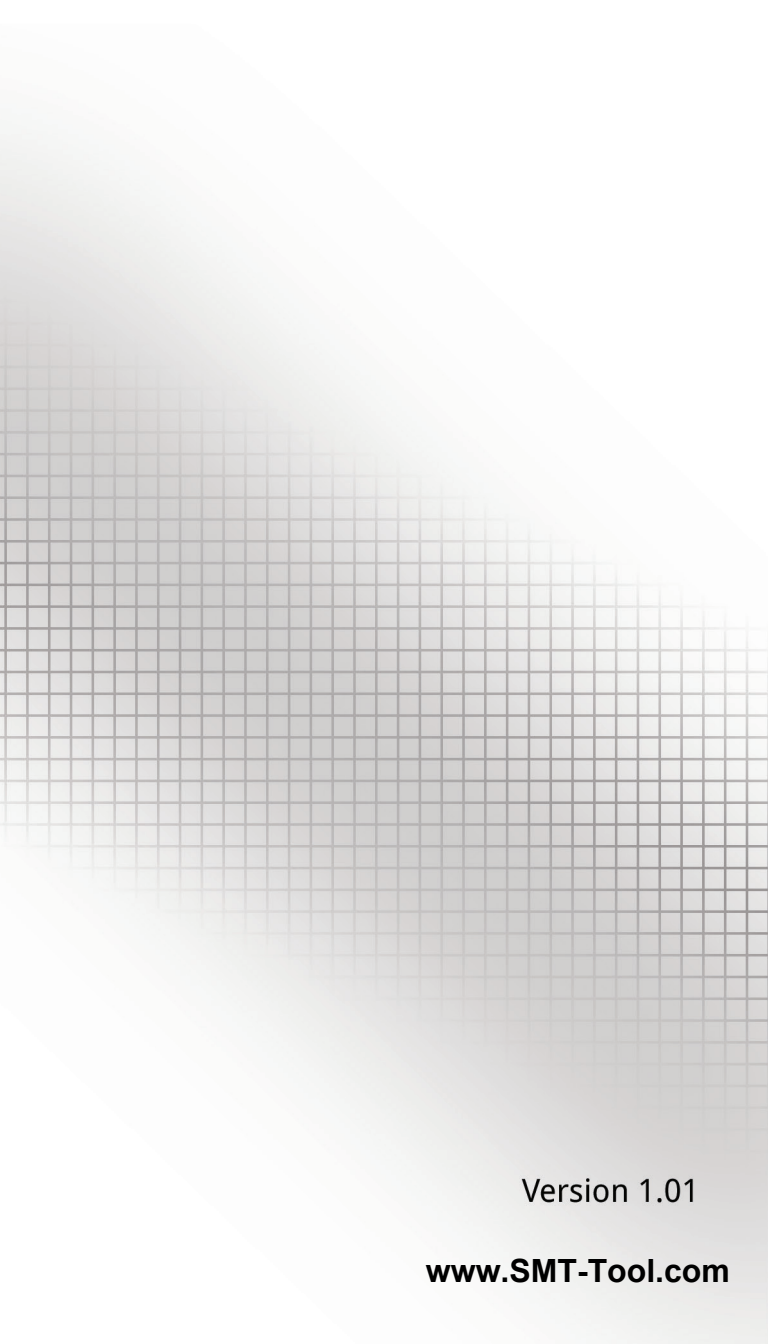

Version 1.01

**[www.SMT-Tool.com](http://www.SMT-Tool.com)**